



COFUNCO S.A.
By Funosa

EXPERTS IN **CAST
IRON MANHOLE
COVERS AND
GRATINGS**



ABOUT US

Cofunco is a company specialising in civil engineering covering and closing products. Our business is based on fast custom service, offering the finest quality products to the various markets we serve. We are exclusive distributors for products manufactured by Funosa, a foundry established in 1916 in Igualada (Barcelona), specialising in ductile and grey cast iron parts.

INTERNATIONAL OUTLOOK

At Cofunco there are no limits to our growth. Our presence throughout Europe allows us to detect new trends, grow, and offer our clients world-class service based in innovation and development.



Our innovation, adaptation capacity and comprehensive management ensure that we achieve what our clients need.





RESOURCES

+50.000 tonnes/year

19.600 m² of built-up surface

Model manufacturing

Painting



ADVANCED TECHNOLOGY

- › Part design:
CAD 3D - CAE-CAM
- › Structural calculation by finite elements
- › Testing laboratory:
Resistance
Metrology
Metallography
Chemistry



COFUNCO S.A.
By Funosa

360° PROJECTS. SATISFACTION FROM ALL ANGLES

From product conception to full time service, we are a motivated leading international industry that is ready to assist you on every step of the way.

Our success stems in large part from Funosa's support as supplier of optimal technological and human resources that guarantee optimal efficiency and service.



QUALITY

Funosa manufactures all of its products under the IATF 16949:2016 quality system, which makes us the only company in the world capable of designing, manufacturing and marketing cast iron pieces for global market. Under this quality system, we offer ergonomic products renowned for their maximum resistance and safety.

Likewise, our products are certified by the corresponding agencies in the market where we operate, guaranteeing compliance with UNE-EN124-2:2015 and all other standards and regulations.

ENVIRONMENT

Preserving the environment is part of Funosa's fundamental responsibilities. This implies compliance with regulations both at the technical and human level, which include compliance with the 14001:2015 Environmental Management Standard.



Funosa is a solid company that respects and fosters processes aimed at **ensuring the highest quality, safety and respect for the environment**



FUNOSA AND COFUNCO

Having Funosa as our partner ensures our success, due to the high quality standards throughout their production process and their finished product. They are IATF 16949 certified and have their own laboratory for controlling cast iron compositions and structures.

At Cofunco we apply this management system to our products ensuring optimal operation and maintenance for the duration of their product life cycle.

- › Manufacturing
- › Design
- › Raw material industrialization and control
- › Production process
- › Quality and Delivery Control

SERVICES OFFERED

SALES DEPARTMENT

Our extensive and experienced sales team, both regionally and internationally, offers quick solutions to our customers' needs.

ENGINEERING DEPARTMENT

We specialize in custom designs, offering effective and innovative solutions adapted to the specific situation of each project.

AFTER-SALES SUPPORT

At the completion of each project, we keep at our customers' disposal a technical guarantee for any incident that may arise on-site, by providing the technical assistance needed to resolve the situation.



↓ APPROVALS

WATER COMPANIES:

- | | | |
|--------------|------------|-------------|
| ➤ Aqualia | ➤ Emuasa | ➤ Huelva |
| ➤ Seragua | ➤ Emasa | ➤ Gihasa |
| ➤ Agbar | ➤ AMVISA | ➤ Emalgesa |
| ➤ Facsa | ➤ Pamplona | ➤ Sercomosa |
| ➤ Emasesa | ➤ Guadix | ➤ EYDAP |
| ➤ Ajemsa | ➤ Galasa | ➤ SEAAL |
| ➤ Aljarafesa | ➤ Apemsa | ➤ SEOR |
| ➤ Huesna | ➤ Chiclana | |
| ➤ Emacsa | Natural | |

POWER COMPANIES:

- | | | |
|-------------|----------|----------------------|
| ➤ Endesa | ➤ Unelco | ➤ Eléctrica de Cádiz |
| ➤ Iberdrola | ➤ Viesgo | ➤ Unión Fenosa |
| ➤ EAE Ceuta | ➤ R.E.E | ➤ Miajadas |

GAS COMPANIES:

- Gas Natural Fenosa

TELECOMMUNICATION COMPANIES:

- | | | |
|--------------|---------------|----------|
| ➤ Telefónica | ➤ CTTI | ➤ Teleco |
| ➤ Vodafone | ➤ | ➤ Orange |
| ➤ Euskatel | Metropolitana | |

PUBLIC AGENCIES AND MUNICIPALITIES:

- | | | |
|-------------------------|-------------------------|---------------------|
| ➤ | ➤ Acosol | ➤ Benidorm |
| Government of Cantabria | ➤ Chipiona | ➤ El Ejido |
| ➤ Vila-Real | ➤ Sanlúcar de Barrameda | ➤ Barcelona |
| ➤ Almería | ➤ San Fernando | ➤ Consortium Bilbao |
| ➤ Frigiliana | ➤ Cáceres | ➤ Cantabria |
| ➤ Seville | ➤ Elche | ➤ Valladolid |
| ➤ Córdoba | | |

↓ RANGE

Cofunco provides an entire range of products as per standard UNE-EN124-2:2015 in terms of cast iron manholes and grates for civil engineering works:

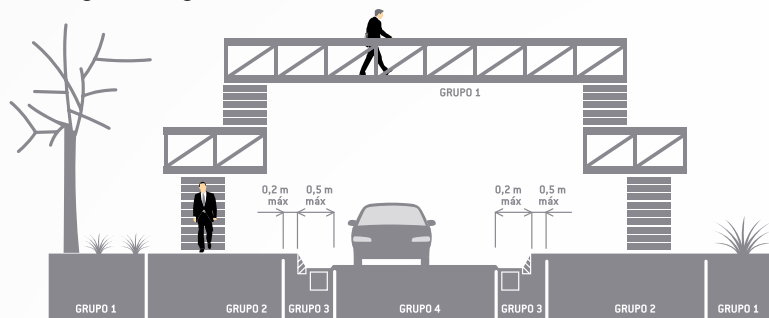

Location of groups according to their location on the public roads as per UNE-EN124-2:2015 definition.



B 125

Group 2 (Class B 125 minimum)

Car parks and pedestrian areas, where occasional vehicular access is likely.



C 250

Group 3 (Class C 250 minimum)

For covers on shoulders and ditch areas of streets up to 50 centimetres into the road and 20 centimetres towards the pavement, both measured from the side of the kerb alongside the road.



D 400

Group 4 (Class D 400 minimum)

Roads (including pedestrian ways), hard shoulders and parking areas for all kinds of vehicles.



E 600

Group 5 (Class E 600 minimum)

Areas where heavy vehicles circulate, such as pavements at airports, docks, etc.



F 900

Group 6 (Class F 900 minimum)

Areas subjected to extreme weight loads – ports and airports.

Loudness generated by vehicles passing over the engraving on a manhole cover:

Sound level obtained from several standard tests based on the following values:
 Vehicle speed 50 km / hr (1800 rpm engine) Peugeot 308 100CV
 Tires: GoodYear Efficient GRP
 Sound level meter: 1.5 m horizontally, 1 m vertically

The sound level values in dBA are also available for speeds between 20 km / hr and 60 km / hr

F900

MATERIAL PRODUCED:

Casted device produced in micro alloy spheroidal graphite. Ductile cast iron according to EN -1563.

COATING:

Epoxy-polyester BLACK ENAMEL, RAL-9004, thickness 100 microns, based on thermo stable plastic resins treated at high temperature. Compliant with Council Directive 1999/13/EC regarding exemption of solvents.



GALAXY F900

HINGED MANHOLE COVER WITH CONTINUOUS ELASTOMERIC GASKET INTENSE TRAFFIC



Set provided with a high performance continuous elastomeric gasket to absorb vibrations and insure soundproofing. The frame secures maximum fixation to pavements. Hinged cover with maximum opening range of 110°, safety blocking at 90° angle and removable from the frame at 90°. Closing system with interlocking perimeter edge. Total or partial customization available. Opening force below 30 daN.



MODEL	COVER DIMENSIONS	FRAME DIMENSIONS	FRAME HEIGHT	CLEAR OPENING	SOUND LEVEL dBA	CERTIFICATE	UNITS PER PALLET
2184	Ø 650 mm	850 x 850 mm	100 mm	Ø 604 mm	82	BVC	6

Options: Locking system, anti-theft



RETEL F900

HINGED MANHOLE COVER INTENSE TRAFFIC



Frame with 4 triangular hinged covers, with maximum opening range of 110° and safety blocking at 90° angle. Hinges are integrated into the frame to provide external edges without ridges for easier installation into the concrete or bricks. Customization available. Opening force below 35 daN.

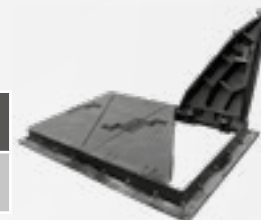

MODEL	COVER DIMENSIONS	FRAME DIMENSIONS	FRAME HEIGHT	CLEAR OPENING	SOUND LEVEL dBA	CERTIFICATE	UNITS PER PALLET
10114 triangles	598 x 780 mm	1285 x 870 mm	100 mm	1180 x 760 mm	79	BVC	5

Options: Locking system with a special head-screw according to the customer specifications. Special steel key with hook to remove cover easily.



GRATINGS RCS F900

CHANNEL GRATING INTENSE TRAFFIC



Grating 300 mm clear opening for channel, 13,6 dm² absorption surface. Anti-slip surface for pedestrian safety.

MODEL	GRATING DIMENSIONS	HEIGHT	ABSORPTION SURFACE	CLEAR OPENING	CERTIFICATE	UNITS PER PALLET
7131	750 x 376 mm	34 mm	13,6 dm ²	300 x 750 mm	BVC	21

Options: Anti-theft system with stainless steel bolts, secures grate to frame, eliminating shifting or movement when traffic passes over and when placed in channel.



E600

MATERIAL:

Casted device produced in micro alloy spheroidal graphite. Ductile cast iron according to EN -1563.

COATING:

EPOXY-POLYESTER BLACK ENAMEL, RAL-9004, thickness 100 microns, based on thermo stable plastic resins treated at high temperature. Compliant with Council Directive 1999/13/EC regarding exemption of solvents.



STARDUST E600

HINGED ACCESS COVER WITH DOUBLE GASKET
INTENSE TRAFFIC



Hinged cover with maximum opening range of 107°, safety blocking at 90° angle and removable from the frame at 90°. Depth of insertion in the frame 80 mm. Lower structure of the cover is formed by 10 main ribs. Closing system with interlocking perimeter edge maximized by weight of the cover. Continuous gaskets in frame and in cover to avoid distortion and partially has the function as hermetic sealing. Customization available.



MODEL	COVER DIMENSIONS	FRAME DIMENSIONS	FRAME HEIGHT	CLEAR OPENING	SOUND LEVEL dBA	CERTIFICATE	UNITS PER PALLET
1187	Ø 676 mm	Ø 850 mm	100 mm	Ø 615 mm	79	IOCERT	8

Options: locking system



GALAXY E600

HINGED MANHOLE COVER WITH ELASTOMERIC GASKET
INTENSE TRAFFIC



Set provided with a high performance continuous elastomeric gasket that absorbs vibrations and insures soundproof. Frame secures maximum fixation to cement on pavement. Hinged cover with maximum opening range of 107°, safety blocking at 90° angle and removable from the frame at 90°. Closing system with interlocking perimeter edge. Opened by standard tools (crowbar, pick). Opening force below 30 daN. Total or partial customization available.



MODEL	COVER DIMENSIONS	FRAME DIMENSIONS	FRAME HEIGHT	CLEAR OPENING	SOUND LEVEL dBA	CERTIFICATE	UNITS PER PALLET
1184	Ø 645 mm	Ø 850 mm	100 mm	Ø 604 mm	82	AFNOR	8
2184	Ø 645 mm	850 x 850 mm	100 mm	Ø 604 mm	82	AFNOR	6

Options: locking system

D400

MATERIAL:

Casted device produced in micro alloy spheroidal graphite. Ductile cast iron according to EN -1563.

COATING:

EPOXY-POLYESTER BLACK ENAMEL, RAL-9004, thickness 100 microns, based on thermo stable plastic resins treated at high temperature. Compliant with Council Directive 1999/13/EC regarding exemption of solvents.



COLUMBIA D400 HINGED MANHOLE COVER WITH APPARENT FRAME OR SQUARE FRAME INTENSE TRAFFIC



Set with clear opening 705mm. Hinged cover with safety blocking at 100° angle and removable from the frame at 90°. Closing with interlocking perimeter edge. Opened by standard tools (crowbar, pick). Customization available. Opening force below 54 daN.

MODEL	COVER DIMENSIONS	FRAME DIMENSIONS	FRAME HEIGHT	CLEAR OPENING	SOUND LEVEL dBA	CERTIFICATE	UNITS PER PALLET
2130-1	Ø 765 mm	900 x 900 mm	100 mm	Ø 705 mm	82	AENOR	8
2134 apparent frame	Ø 765 mm	910 x 910 mm	130 mm	Ø 705 mm	82	AENOR	8



KOPERNIK D400 HINGED ACCESS COVER WITH GASKET INTENSE TRAFFIC

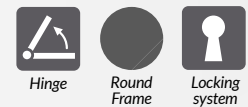

Access cover with maximum opening range 120°, safety blocking at 90° angle and removable from the frame at 90°. Depth of insertion 59 mm. Lower structure of the lid is formed by 8 main ribs. Continuous, reinforced gasket to avoid distortion and partially serves as hermetic sealing. Closing system with interlocking perimeter edge. Customization available.

MODEL	COVER DIMENSIONS	FRAME DIMENSIONS	FRAME HEIGHT	CLEAR OPENING	SOUND LEVEL dBA	CERTIFICATE	UNITS PER PALLET
1191	Ø 635 mm	Ø 770 mm	150 mm	Ø 600 mm	82	IOCERT	8
1193	Ø 635 mm	Ø 770 mm	115 mm	Ø 600 mm	82	IOCERT	10



ORION D400 HINGED ACCESS COVER WITH ELASTOMERIC GASKET AND ELASTIC CLOSING SYSTEM NORMAL TRAFFIC



Access cover with 700 mm clear opening. Hinged cover with maximum opening range of 120°, safety blocking at 90° angle and removable from the frame at 90°. Closing system operated by two elastic bars. Anti-residue joint design. Anti-slip surface. Elastomeric gasket for stability and noise reduction. Anti-slip surface. Opened by standard tools (crowbar, pick). Opening force below 54 daN.

MODEL	COVER DIMENSIONS	FRAME DIMENSIONS	FRAME HEIGHT	CLEAR OPENING	SOUND LEVEL dBA	CERTIFICATE	UNITS PER PALLET
1168	Ø 745 mm	Ø 1.000 mm	150 mm	Ø 700 mm	81	AENOR	8

Options: locking system

VOYAGER D400

HINGED ACCESS COVER WITH ELASTOMERIC GASKET IN ENTIRE FRAME PERIMETER AND ELASTIC CLOSING SYSTEM
NORMAL TRAFFIC



Set of 600mm clear opening and hinged cover with maximum opening range of 120°, safety blocking at 90° angle and removable from the frame at 90°. New patented elastic closing system. Continuous gasket to avoid distortion and partially serves as hermetic sealing. Customization available.



MODEL	COVER DIMENSIONS	FRAME DIMENSIONS	FRAME HEIGHT	CLEAR OPENING	SOUND LEVEL dBA	CERTIFICATE	UNITS PER PALLET
1173*	Ø 635 mm	Ø 785 mm	100 mm	Ø 600 mm	82	BVC/IOCERT	12
2173	Ø 635 mm	810 x 810 mm	75 mm	Ø 600 mm	82	BVC	12
6173 grating	Ø 635 mm	Ø 791 mm	100 mm	Ø 600 mm	-	IOCERT	12

*Options: locking system, ventilated cover

COSMOS D400

HINGED ACCESS COVER WITH ELASTOMERIC GASKET AND ELASTIC CLOSING SYSTEM
NORMAL TRAFFIC



Set of 600mm clear opening. Available with 850mm and 790mm exterior diameter. Hinged cover with maximum opening range of 120°, safety blocking at 90° angle and removable from the frame at 90°. Closing system operated by two elastic bars. Anti-residue elastomeric gasket design for stability and noise reduction. Anti-slip surface. Opened by standard tools (crowbar, pick). Available in ventilated cover model 1164VENT and grating model 6184 intense traffic (11,8 dm² absorption surface) and model 6174. All frames may be substituted for concrete cover model 1186. Opening force below 17,5 daN. Total or partial customization available.

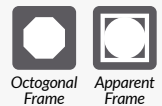

MODEL	COVER DIMENSIONS	FRAME DIMENSIONS	FRAME HEIGHT	CLEAR OPENING	SOUND LEVEL dBA	CERTIFICATE	UNITS PER PALLET
1164*	Ø 645 mm	Ø 850 mm	100 mm	Ø 600 mm	82	AENOR/AFNOR	10
2164*	Ø 645 mm	850 x 850 mm	100 mm	Ø 600 mm	82	AENOR/AFNOR	6
2131	Ø 645 mm	850 mm frame 750 mm cover surface	100 mm apparent frame	Ø 600 mm	82	BVC	6

*Options: anti-opening block with two elastic bars by screw and nut with fixation, anti-theft hinge

METEOR D400

HINGED MANHOLE COVER WITH CONCRETE FILLER AND FRAME IN DUCTILE IRON WITH ELASTOMERIC GASKET

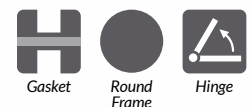

Set of 604mm clear opening. Hinged cover with maximum opening range of 120° and safety blocking at 90° angle. Anti-residue elastomeric ring design for stability and noise reduction. Self-locking fixation to better secure product to pavement. Closing system with interlocking perimeter edge maximized by cover's weight. Anti-slip surface. Opened by standard tools (crowbar, pick). Opening force below 30 daN.

MODEL	COVER DIMENSIONS	FRAME DIMENSIONS	FRAME HEIGHT	CLEAR OPENING	SOUND LEVEL dBA	CERTIFICATE	UNITS PER PALLET
1186	Ø 650 mm	Ø 790 mm	100 mm	Ø 600 mm	80,5	IOCERT	5

Options: locking system





RETEL D400

HINGED ACCESS COVER WITH ELASTOMERIC GASKET AND ELASTIC CLOSING SYSTEM

NORMAL TRAFFIC

Access cover with clear opening 804mm. Hinged cover with maximum opening range of 120°, safety blocking at 90° angle and removable from the frame at 90°. Closing system operated by of two elastic bars. Anti-residue joint design. Elastomeric gasket for stability and noise reduction. Anti-slip surface. Opened by standard tools (crowbar, pick). Opening force below 30 daN.



MODEL	COVER DIMENSIONS	FRAME DIMENSIONS	FRAME HEIGHT	CLEAR OPENING	SOUND LEVEL dBA	CERTIFICATE	UNITS PER PALLET
1108-08	Ø 840 mm	1000 x 920 mm	120 mm	Ø 804 mm	81	IOCERT AFNOR	8

Options: locking system



APOLO D400

AIR/WATER TIGHT MANHOLE COVER AND FRAME

NORMAL TRAFFIC

Set of 600 mm clear opening. Air and Water tight sealed below 1 bar of pressure. The hermetic seal is secured by 4 closures of stainless steel bolts to avoid seizing, equipped with non-loosening washers for vibration.

Anti-slip surface designed for pedestrian safety. Opened by standard tools (crowbar, pick). Opening force below 30 daN. Customization available.



MODEL	COVER DIMENSIONS	FRAME DIMENSIONS	FRAME HEIGHT	CLEAR OPENING	SOUND LEVEL dBA	CERTIFICATE	UNITS PER PALLET
1122	Ø 655 mm	Ø 850 mm	75 mm	Ø 600 mm	81	AFNOR	10



TITAN D400

ACCESS COVER WITH CLOSING SYSTEM

MODERATE TRAFFIC

Access cover with clear opening of Ø 604mm, perfectly centered in frame. Provided with spring closing system and handle for easy opening. Anti-slip surface design for pedestrian safety. Anti-residue elastomeric gasket for stability and noise reduction. Opened by standard tools (crowbar, pick). Opening force below 12 daN. Customization available.



MODEL	COVER DIMENSIONS	FRAME DIMENSIONS	FRAME HEIGHT	CLEAR OPENING	SOUND LEVEL dBA	CERTIFICATE	UNITS PER PALLET
1178	Ø 645 mm	Ø 850 mm	100 mm	Ø 604 mm	82	AFNOR	5

Options: locking system



ARCHILIFT D400

HINGED ACCESS COVER WITH LOCKING SYSTEM AND KEY

NORMAL TRAFFIC

Access cover of 760x760mm clear opening. Hinged cover with maximum opening range of 110°. Hinge with spring system for easy handling. Cover includes a hermetic gasket and has an anti-slip surface especially designed with a slight slope so that water is eliminated quickly. Anti-theft closing system and lifting key included. The typical usage of this product is for accesses to the carburant deposits in petrol stations. Customization available.



MODEL	COVER DIMENSIONS	FRAME DIMENSIONS	FRAME HEIGHT	CLEAR OPENING	SOUND LEVEL dBA	CERTIFICATE	UNITS PER PALLET
3193	840 x 840 mm	1015 x 920 mm	100 mm	760 x 760 mm	82	BVC	8

Options: ergonomic lifting key with long handle, customizable with an adapted head, usable as a grip for opening and closing



SPREE D400 GRATING NORMAL TRAFFIC



Set of grating and frame provided with dual steel elastic closing system (patented). Grating supported in frame in four points separated by special gasket with high hardness and durability for stability and noise reduction. Interior part of frame with round form to install a basket for solid waste collection. Anti-slip surface. Opened by standard tools (crowbar, pick).



MODEL	GRATING DIMENSIONS	FRAME DIMENSIONS	FRAME HEIGHT	CLEAR OPENING	ABSORPTION SURFACE
5170	505 x 295 mm	520 x 305 mm	100 mm	363 x 291 mm	5,9 dm ²

Options: locking system.



EOS D400 HINGED MANHOLE COVER WITH GASKET NORMAL TRAFFIC



Hinged cover with maximum opening range of 110°, safety blocking at 100° angle and removable from the frame at 90°. Anti-residue elastomeric gasket designed for stability and noise reduction. Self-locking fixation to better secure frame to pavement. Closing system with interlocking perimeter edge maximized by cover weight. Anti-slip surface. Opened by standard tools (crowbar, pick). Customization available.

MODEL	COVER DIMENSIONS	FRAME DIMENSIONS	FRAME HEIGHT	CLEAR OPENING	SOUND LEVEL dBA	CERTIFICATE	UNITS PER PALLET
31110	328x328 mm	415x415 mm	75 mm	301x301 mm	79	AFNOR*	12
31111	424 x 424 mm	508 x 525 mm	100 mm	400 x 400 mm	79	AFNOR	8
31112	524 x 538 mm	608 X 628 mm	100 mm	500 x 500 mm	79	AFNOR	8
31113	624 x 638 mm	708 x 737 mm	105 mm	600 x 600 mm	79	AFNOR	5
31114	724x737 mm	808x844 mm	100 mm	700x700 mm	79	AFNOR*	5
31115	828x828 mm	908x954mm	100 mm	800x800 mm	79	AFNOR* IOCERT	5



Options: locking system

*In the process of certification



EOS GRATING D400 HINGED GRATING WITH GASKET NORMAL TRAFFIC



Hinged grating with maximum opening range of 110°, safety blocking at 100° angle and removable from the frame at 90°. Anti-residue elastomeric gasket designed for stability and noise reduction. Self-locking fixation to better secure frame to pavement. Closing system with interlocking perimeter edge maximised by cover weight. Anti-slip surface. Opened by standard tools (crowbar, pick).

MODEL	COVER DIMENSIONS	FRAME DIMENSIONS	FRAME HEIGHT	CLEAR OPENING	ABSORPTION SURFACE	CERTIFICATE	UNITS PER PALLET
51110	328x328 mm	415x415 mm	75 mm	301x301 mm	2,85 dm ²	AFNOR *	12
51111	424x424 mm	508x525 mm	100 mm	400x400 mm	5,8 dm ²	AFNOR	8
51112	524x524 mm	608x628 mm	100 mm	500x500 mm	8,7 dm ²	AFNOR	8
51113	624x638 mm	708x737 mm	100 mm	600x600 mm	12,4 dm ²	AFNOR	5
51114	724x737 mm	808x844 mm	100 mm	700x700 mm	18,2 dm ²	AFNOR *	5
51115	828x828 mm	908x954mm	100 mm	800x800 mm	25,1 dm ²	AFNOR *	5



Options: locking system

*In the process of certification



C-EOS D400 CONCAVE GRATING – PRM NORMAL TRAFFIC



Hinged grating with 120° concave slope and maximum opening range of 110°. Closing system with interlocking perimeter edge maximized by grating's weight. Anti-slip surface. Opened by standard tools (crowbar, pick).



MODEL	GRATING DIMENSIONS	FRAME DIMENSIONS	FRAME HEIGHT	CLEAR OPENING	ABSORPTION SURFACE	CERTIFICATE
5172	330 x 330 mm	420 x 420 mm	100 mm	307 x 307 mm	4,45 dm ²	AFNOR
5173	430 x 430 mm	520 x 520 mm	100 mm	407 x 407 mm	8,26 dm ²	AFNOR
5174	530 x 530 mm	620 x 620 mm	100 mm	507 x 507 mm	12,12 dm ²	AFNOR
5175	630 x 630 mm	720 x 720 mm	100 mm	620 x 620 mm	15,1 dm ²	AFNOR
5176	730,5 x 735 mm	820 x 820 mm	100 mm	710 x 710 mm	18,8 dm ²	AFNOR

Options: Anti-theft hinge



GALAXY D400 GRATING HINGED GRATING PRM WITH ELASTOMERIC GASKET INTENSE TRAFFIC



Set with clear opening Ø604mm. Hinged grating with maximum opening range of 110°, safety blocking at 90° angle and removable from the frame at 90°. Frame equipped with gasket to prevent noise and vibration. Closing system with interlocking perimeter edge. Bar design according to PRM regulation and to provide maximum water drainage. Opened with standard tool (crowbar, pick).



MODEL	GRATING DIMENSIONS	FRAME DIMENSIONS	FRAME HEIGHT	CLEAR OPENING	ABSORPTION SURFACE	CERTIFICATE	UNITS PER PALLET
6184	Ø 645 mm	Ø 850 mm	100 mm	Ø 604 mm	11,8 dm ²	AFNOR	6

Options: Anti-theft hinge



COSMOS GRATING D400 HINGED GRATING WITH ELASTOMERIC GASKET AND ELASTIC CLOSING SYSTEM NORMAL TRAFFIC



Set of 600 mm clear opening available in 850mm and 790mm exterior diameter. Hinged cover with maximum range of 120°, safety blocking at 90° and removable from the frame at 90°. Closing system operated by two elastic bars. Anti-residue elastomeric gasket design for stability and noise reduction. Anti-slip surface. Opened by standard tools (crowbar, pick). Opening force below 16,5 daN.

MODEL	GRATING DIMENSIONS	FRAME DIMENSIONS	FRAME HEIGHT	CLEAR OPENING	ABSORPTION SURFACE	CERTIFICATE	UNITS PER PALLET
6174	Ø 645 mm	Ø 850 mm	100 mm	Ø 600 mm	11,8 dm ²	AFNOR	10

Options: anti-opening block with two spring bars by screw and nut with fixation. anti-theft hinge



AQUA D400 HINGED GRATING NORMAL TRAFFIC



Set includes grate and frame. Hinge provided with anti-theft screw. Anti-slip surface. Opened by standard tools (crowbar, pick). Opening force below 17 daN.

MODEL	GRATING DIMENSIONS	FRAME DIMENSIONS	FRAME HEIGHT	CLEAR OPENING	ABSORPTION SURFACE	CERTIFICATE	UNITS PER PALLET
5121	600 x 350 mm	730 x 420 mm	80 mm	550x297mm	11,10 dm ²	AENOR	30





MAREMAGNUM D400

HINGED GRATING FOR MODULAR/LINEAL FORMATION

NORMAL TRAFFIC



Set of frame and hinged grating with maximum opening range of 120° and anti-closing security block. Minimal gap that ensures perfect grate fitting in the frame. Appropriate for flooding roads. Great absorption capabilities (22,3 dm²). Modular grating available with perpendicular installation at the kerb or crossing of the intercepting road. Opening force below 22 daN.



MODEL	GRATING DIMENSIONS	FRAME DIMENSIONS	FRAME HEIGHT	CLEAR OPENING	ABSORPTION SURFACE	CERTIFICATE	UNITS PER PALLET
5152	754 x 504 mm	828 x 578 mm	100 mm	690 x 440 mm	22,3 dm ²	AENOR	10



Options: to adjust the size to the width of the end of the road you can optionally add the 5153 module (dimensions 500mm wide and length 250mm). Class C-250. Non-jointed. Self-locking anchorage to better secure the product to pavement)



VOLGA D400

GRATING WITH HINGE

PRM



Set of grating and frame with anti-theft hinge. Sinusoidal bars designed to prevent water accumulation at the ends of the set and provide maximum water drainage. Anti-slip surface.

MODEL	GRATING DIMENSIONS	FRAME DIMENSIONS	FRAME HEIGHT	CLEAR OPENING	ABSORPTION SURFACE	CERTIFICATE
5151	730X280 mm	815X365 mm	80 mm	301x301mm	11,45 dm ²	AFNOR *

Options: reinforced frame



BALTIKA D400

HINGED GRATING WITH ELASTIC CLOSING SYSTEM

NORMAL TRAFFIC



Set of grating and frame with 3 type of frame – round, half-round, square. Hinged grating with maximum opening range of 120° and elastic closing system. Anti-theft hinge.

MODEL	GRATING DIMENSIONS	FRAME DIMENSIONS	FRAME HEIGHT	CLEAR OPENING	ABSORPTION SURFACE	CERTIFICATE
5126.10	598x397 mm	471x650 mm	115 mm	500X356 mm	11 dm ²	IOCERT
5126.20	598x397 mm	570x650 mm	115 mm	500X356 mm	11 dm ²	IOCERT
5126.30	598x397 mm	670x650 mm	115 mm	500X356 mm	11 dm ²	IOCERT
5130.10	598x397 mm	471x650 mm	150 mm	500X356 mm	11 dm ²	IOCERT
5130.20	598x397 mm	570x650 mm	150 mm	500X356 mm	11 dm ²	IOCERT
5130.30	598x397 mm	670x650 mm	150 mm	500X356 mm	11 dm ²	IOCERT

Options: locking system



TELESKOP HUBBLE D400



Connection box for the pipe 400 mm exterior dimension. Depth of insertion of the frame in the pipe 30mm

MODEL	COVER DIMENSIONS	FRAME DIMENSIONS	FRAME HEIGHT	CLEAR OPENING	CERTIFICATE
1190	Ø 378 mm	Ø 475 mm	100 mm	Ø 345mm	IOCERT
1192	Ø 302mm	356 x 356 mm	34 mm	Ø 261mm	IOCERT

Options: set available in class B125

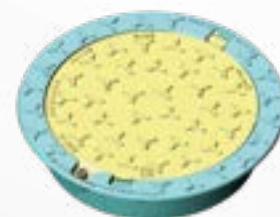

C250

MATERIAL:
Casted device produced in micro alloy spheroidal graphite. Ductile cast iron according to EN -1563.
COATING:
EPOXY-POLYESTER BLACK ENAMEL, RAL-9004, thickness 100 microns, based on thermo stable plastic resins treated at high temperature. Compliant with Council Directive 1999/13/EC regarding exemption of solvents.



MARE C250 GRATING WITH HINGE LIGHT TRAFFIC - PRM



Hinge



Square Frame



PRM friendly

Set of grating and frame 700x280 mm with anti-theft hinge. Maximum opening range of 110°. Sinusoidal bars designed to prevent water accumulation at the ends of the set and provide maximum water drainage. Anti-slip surface. Opened by standard tools (crowbar, pick).
Opening force below 18 daN.



MODEL	GRATING DIMENSIONS	FRAME DIMENSIONS	FRAME HEIGHT	CLEAR OPENING	ABSORPTION SURFACE	CERTIFICATE	UNITS PER PALLET
5150	750 x 300 mm	816 x 345 mm	55 mm	700 x 280 mm	11,2 dm ²	AFNOR	30



MARE C250 RECTANGULAR HINGED GRATING LIGHT TRAFFIC



Hinge



Square Frame

Set of grating and frame with anti-theft hinge. Opening of up to 100°. Bars special design with lateral opening to prevent water accumulation at the ends of the set and provide maximum water drainage. Opening force below 18 daN. Anti-slip surface. Opened by standard tools (crowbar, pick).

MODEL	GRATING DIMENSIONS	FRAME DIMENSIONS	FRAME HEIGHT	CLEAR OPENING	ABSORPTION SURFACE	CERTIFICATE	UNITS PER PALLET
5111	385 x 285 mm	450 x 330 mm	40 mm	355 x 250 mm	3,50 dm ²	BVC	50
5114*	375 x 320 mm	530 x 350 mm	100 mm	375 x 310 mm	5,35 dm ²	BVC	14
5119	480 x 235 mm	504 x 254 mm	40 mm	462 x 202 mm	4,00 dm ²	BVC	72
5112	490 x 335 mm	548 x 377 mm	40 mm	490 x 300 mm	9,20 dm ²	BVC	40
5110	600 x 350 mm	730 x 420 mm	80 mm	550 X 297 mm	11,10 dm ²	BVC	30
5128	650 x 300 mm	685 x 383 mm	38 mm	622 x 271 mm	10,04 dm ²	AENOR	45
5104	650 x 300 mm	750 x 360 mm	36 mm	625 x 270 mm	7,95 dm ²	BVC	40
5122	735 x 282 mm	820 x 350 mm	100 mm	700 x 250 mm	9,70 dm ²	AFNOR	24
5127	735 x 282 mm	880 x 375 mm	100 mm	700 x 300 mm	9 dm ²	AFNOR	24
5101	755 x 240 mm	840 x 345 mm	38 mm	720 x 215 mm	8,67 dm ²	BVC	60
5129	735 x 280 mm	815 x 359 mm	100 mm	700 x 295 mm	4 dm ²	AFNOR	24



Options: anti-theft bolt



URBEX C250 HINGED MANHOLE COVER AND HINGED GRATING WITH GASKET LIGHT TRAFFIC - PRM



Hinge



Soporte eléctrico



Safety Blocking



PRM friendly

Set of 604mm clear opening. Anti-slip surface. The elastomeric gasket ensures stability and noise reduction. With handle designed for lifting with multiple tools. Model 6177 grating cover. Opening force below 15 daN. Customization available.



MODEL	COVER DIMENSIONS	FRAME DIMENSIONS	FRAME HEIGHT	CLEAR OPENING	CERTIFICATE	UNITS PER PALLET
1177*	Ø 645 mm	Ø 850 mm	75 mm	Ø 604 mm	AFNOR	12
6177	Ø 645 mm	Ø 850 mm	75 mm	Ø 604 mm	AFNOR	12

***Options:** locking system, ventilated cover

BBR C250

HYDRAULIC HINGED COVER FOR PIPE INSTALLATIONS WITH GASKET

PREF C250 / B125

HYDRAULIC HINGED COVER WITH CONCRETE FRAME

LIGHT TRAFFIC

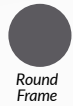

Hinge

Square
FrameRound
Frame

Set of frame and cover for direct installation of pipe. With special round gasket for hermetic closing between pipe and frame. Hinge with anti-theft bolt. Hydraulic frame prevents odour leakage. Anti-slip surface. Opened by standard tools (crowbar, pick). Customization available. Opening force below 5 daN.

MODEL	COVER DIMENSIONS	FRAME DIMENSIONS	FRAME HEIGHT	CLEAR OPENING	PIPE	CERTIFICATE	UNITS PER PALLET
2145	Ø 206 mm	Ø 302 x 282 mm	125 mm	Ø 180 mm	Ø 250 mm	AFNOR	24
2146-1	Ø 260 mm	Ø 356 x 356 mm	150 mm	Ø 233 mm	Ø 315 mm	AFNOR	24
2147	Ø 360 mm	Ø 446 x 426 mm	185 mm	Ø 330 mm	Ø 400 mm	AFNOR	12
2148*	Ø 265 mm	Ø 390 mm	150 mm	Ø 225 mm	Ø 315 mm	AFNOR	18
2149	Ø 390 mm	Ø 484 mm	150 mm	Ø 350 mm	Ø 405 mm	AFNOR	12

*Options: locking bolt, model 2150 without hinge

**PKLUM C250**

HALF HINGED HYDRAULIC ACCESS COVER

LIGHT TRAFFIC



Square manhole cover with hydraulic frame. Half-hinged cover with a stable opening position at 105°, equipped with guiding system for closing manoeuvres that ensures perfect fitting of cover in frame. The cover is supplied with a perimeter ridge that produces an hydraulic closing effect within the frame. Cover with a slot to facilitate lifting. Internal legs to improve installation. Opening force below 15 daN.

MODEL	COVER DIMENSIONS	FRAME DIMENSIONS	FRAME HEIGHT	CLEAR OPENING	CERTIFICATE	UNITS PER PALLET
31109	388 x 388 mm	400 x 400 mm	50 mm	305 x 305 mm	AFNOR	12
31962	456 x 438 mm	472 x 454 mm	45 mm	400 x 400 mm	AFNOR	12
31972	556 x 538 mm	573 x 555 mm	45 mm	500 x 500 mm	AFNOR	12
3194*	676 x 676 mm	705 x 705 mm	45 mm	618 x 618 mm	AFNOR	6
3182*	775 x 775 mm	800 x 800 mm	45 mm	670 x 670 mm	AFNOR	5

*Options: locking bolt, anti-theft chain

Square
Frame**RON C250**

FLAT GRATINGS WITH ELASTIC CLOSING SYSTEM

LIGHT TRAFFIC



Set of grating and frame with anti-theft hinge. Opening up to 110°. Closing system operated by two spring bars. Grating supported in frame by using "V" shaped legs to achieve better stability and avoid movements. Model 5138, 5139 have higher frame for better anchorage of product to pavement. Anti-slip surface. Opened by standard tools (crowbar, pick). Opening effort below 12 - 26 daN.

MODEL	GRATING DIMENSIONS	FRAME DIMENSIONS	FRAME HEIGHT	CLEAR OPENING	ABSORPTION SURFACE	CERTIFICATE	UNITS PER PALLET
5135	348 x 348 mm	410 x 410 mm	50 mm	315 x 315 mm	7,02 dm ²	AFNOR	36
5136	448 x 448 mm	510 x 510 mm	50 mm	415 x 415 mm	12,1 dm ²	AFNOR	32
5137	528 x 528 mm	590 x 590 mm	50 mm	495 x 495 mm	18,2 dm ²	AFNOR	16
5138	628 x 628 mm	690 x 690 mm	60 mm	595 x 595 mm	26 dm ²	AFNOR	8



Hinge

Square
FrameLocking
system**RIU C250**

CONCAVE GRATING

LIGHT TRAFFIC



Grating with concave bar design for maximum water absorption. Anti-slip surface. Opened by standard tools (crowbar, pick).

MODEL	GRATING DIMENSIONS	FRAME DIMENSIONS	FRAME HEIGHT	CLEAR OPENING	ABSORPTION SURFACE	CERTIFICATE	UNITS PER PALLET
6112	440 x 300 mm	490 x 350 mm	47 mm	405 x 257 mm	5,7 dm ²	BVC	52
6114	525 x 325 mm	550 x 350 mm	40 mm	485 x 285 mm	8,3 dm ²	BVC	52

Square
Frame



RON H C250

FLAT GRATINGS PRM WITH ELASTIC CLOSING SYSTEM

LIGHT TRAFFIC - PRM

Set of grating and frame with anti-theft hinge. Opening of up to 110°. Closing system operated by two spring bars. Grating supported in frame by using "V" shaped legs to achieve better stability and avoid movements. Model 5158, 5139 have higher frame for better anchorage the product to pavement. Anti-slip surface. Opened by standard tools (crowbar, pick). Opening force below 12 - 26 daN.



MODEL	GRATING DIMENSIONS	FRAME DIMENSIONS	FRAME HEIGHT	CLEAR OPENING	ABSORPTION SURFACE	CERTIFICATE	UNITS PER PALLET
5154	262 x 264 mm	325 x 325 mm	45 mm	235 x 235 mm	3,7 dm ²	AFNOR	36
5155	347 x 348 mm	410 x 410 mm	50 mm	318 x 315 mm	6,5 dm ²	AFNOR	36
5156	448 x 448 mm	510 x 510 mm	50 mm	418 x 415 mm	10 dm ²	AFNOR	20
5157	528 x 528 mm	590 x 590 mm	50 mm	495 x 495 mm	15,4 dm ²	AFNOR	16
5158	627 x 627 mm	690 x 690 mm	60 mm	600 x 600 mm	19,3 dm ²	AFNOR	8
5139	728 x 728 mm	790 x 790 mm	85 mm	695 x 695 mm	26 dm ²	AFNOR	5



RON EC C250

CONCAVE GRATING WITH HINGE AND ELASTIC CLOSING SYSTEM

LIGHT TRAFFIC

Set of concave grate and frame with a 120° concave slope. Opening of up to 110°. Closing system operated by two spring bars. Grating supported in frame by using "V" shaped legs to achieve better stability and avoid movements. Special design bars with lateral opening to prevent water accumulation at the ends of the set and provide maximum drainage. Opening force below 15 daN. Anti-slip surface. Opened by standard tools (crowbar, pick).



MODEL	GRATING DIMENSIONS	FRAME DIMENSIONS	FRAME HEIGHT	CLEAR OPENING	ABSORPTION SURFACE	CERTIFICATE	UNITS PER PALLET
5145	348 x 348 mm	410 x 410 mm	75 mm	315 x 315 mm	7,5 dm ²	AFNOR/BVC	36
5146	448 x 448 mm	510 x 510 mm	80 mm	415 x 415 mm	12,7 dm ²	AFNOR/BVC	20
5147	528 x 498 mm	590 x 560 mm	75 mm	495 x 465 mm	18,3 dm ²	AFNOR/BVC	16



RON EC H C250

CONCAVE GRATING WITH HINGE AND ELASTIC CLOSING SYSTEM

LIGHT TRAFFIC - PRM

Set of concave grate and frame with a 120° concave slope. Opening of up to 110°. Closing system operated by two spring bars. Grating supported in frame by using "V" shaped legs to achieve better stability and avoid movements. Special design bars with lateral opening to prevent water accumulation at the ends of the set and provide maximum water drainage. Opening effort below 15 daN. Anti-slip surface. Opened by standard tools (crowbar, pick).



MODEL	GRATING DIMENSIONS	FRAME DIMENSIONS	FRAME HEIGHT	CLEAR OPENING	ABSORPTION SURFACE	CERTIFICATE	UNITS PER PALLET
5165	364 x 364 mm	410 x 410 mm	70 mm	320 x 320 mm	6,4 dm ²	AFNOR	36
5166	464 x 464 mm	510 x 510 mm	75 mm	422 x 422 mm	10,7 dm ²	AFNOR	20
5167	574 x 574 mm	620 x 620 mm	70 mm	532 x 532 mm	15 dm ²	AFNOR	8
5168	630 x 630 mm	720 x 720 mm	100 mm	610 x 422 mm	15,1 dm ²	AFNOR*	5
5169	733,5 x 735 mm	820 x 820 mm	100 mm	710 x 710 mm	18,8 dm ²	AFNOR*	5



*In the process of certification



OCEAN C250

CHANNEL GRATING WITH HINGE AND CLOSING SYSTEM

LIGHT TRAFFIC - PRM

Grating for modular mounting for perpendicular installation at the kerb or crossing of the intercepting road. Easy opening for gutter cleaning operations. Anti-slip surface. With closing system on one side and articulation on the other side.



MODEL	GRATING DIMENSIONS	FRAME HEIGHT	ABSORPTION SURFACE	CERTIFICATE	UNITS PER PALLET
7127	778 x 195 mm	25 mm	7 dm ²	AFNOR	30
7128	750 x 300 mm	27 mm	11,0 dm ²	AFNOR	20
7129	750 x 400 mm	27 mm	17 dm ²	AFNOR	12
7130 non PRM	755 x 500 mm	35 mm	19 dm ²	AFNOR	12

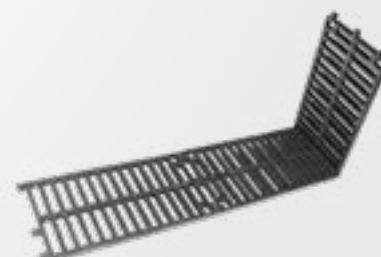



DOURO / TEJO C250

GRATING

PRM



Hinged gratings with maximum opening range of 110°, safety blocking at 90° angle. Anti-theft hinge after installation. Closing system with interlocking perimeter edge. The grate in closed position keeps clamped with the frame, so to avoid rocking and clanking. The grate has an embossed design to impede the water flow and redirect it to fall inside. Frames with optimized supports to guarantee a correct fitting. Opened by standard tools (crowbar, pick).



MODEL	GRATING DIMENSIONS	FRAME DIMENSIONS	FRAME HEIGHT	CLEAR OPENING	ABSORPTION SURFACE	CERTIFICATE
5179	600x250 mm	650x275 mm	40 mm	590 x 240 mm	7,2 dm ²	BVC
5180	660x355 mm	700x375 mm	40 mm	650 x 345 mm	10,7 dm ²	BVC



BOR C250

KERB DRAIN WITH MANHOLE COVER

Kerb with round cover with clear opening 600 mm. Maximum water drainage. Anti-slip surface. Opened by standard tools (crowbar, pick). Customization available.

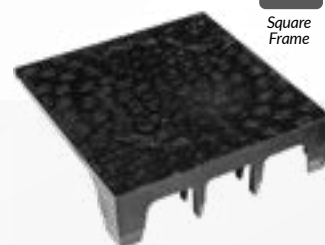

MODEL	KERB DIMENSIONS	COVER DIMENSIONS	KERB HEIGHT	ABSORPTION SURFACE	CERTIFICATE	UNITS PER PALLET
8122-1	800 x 781 mm	Ø 600 mm	200 mm	4,4 dm ²	AFNOR	6
8125	800 x 792 mm	Ø 600 mm	120 mm	7,7 dm ²	AFNOR	6



BOR C250

KERB DRAIN

Kerb with maximum water drainage. Anti-slip surface. Opened by standard tools (crowbar, pick). Customization available.

MODEL	KERB DIMENSIONS	KERB HEIGHT	ABSORPTION SURFACE	CERTIFICATE	UNITS PER PALLET
8104	800 x 150 mm	195 mm	7,76 dm ²	AFNOR	20
8105	835 x 225 mm	120 mm	5,4 dm ²	AFNOR	5
8121	540 x 140 mm	250 mm	7 dm ²	-	24



AMAZON C250

KERB - GRATING WITH SQUARE COVER, WITH HINGE AND ELASTIC CLOSING SYSTEM

PRM



Kerb with grating and hinged cover. Maximum opening range of 110° leaving clear opening at 337mm. Anti-slip surface. Grating supported in frame by using "V" shaped legs to achieve better stability and avoid movement. Opening force below 10 daN.



MODEL	KERB DIMENSIONS	GRATING DIMENSIONS	KERB HEIGHT	CLEAR OPENING	ABSORPTION SURFACE	CERTIFICATE	UNITS PER PALLET
8126	499 x 499 mm	600 x 537 mm	125mm/90mm	337 mm	10 dm ²	AFNOR	8
8127	499 x 499 mm	601 x 536 mm	205mm/90mm	337 mm	13,5 dm ²	AFNOR	8



NIL C250

KERB - WITH SQUARE HINGED COVER AND GRATING PRM WITH ELASTIC CLOSING



Kerb opens at 110° and has clear opening of 405mm. Bar design according to PRM regulation and to provide maximum water drainage. Grating supported in frame by using "V" shaped legs to achieve better stability and avoid movement. Customization available.



MODEL	KERB DIMENSIONS	FRAME DIMENSIONS	KERB HEIGHT	CLEAR OPENING	ABSORPTION SURFACE	CERTIFICATE	UNITS PER PALLET
8128	503 X 488 mm	584 x 523 mm	235 mm/ 122 mm	405 mm	11,2 dm ²	AFNOR	8

B125

MATERIAL:

Casted device produced in micro alloy spheroidal graphite. Ductile cast iron according to EN -1563.

COATING:

EPOXY-POLYESTER BLACK ENAMEL, RAL-9004, thickness 100 microns, based on thermo stable plastic resins treated at high temperature. Compliant with Council Directive 1999/13/EC regarding exemption of solvents.



PAS B125

PEDESTRIAN AREA ACCESS COVER WITH GASKET



Hinge



Octagonal frame

Cover equipped with anti-theft bolt in the hinge, opening of up to 120°. Anti-residue elastomeric gasket designed for stability and noise reduction. Anti-slip surface. Opened by standard tools (crowbar, pick). Opening force below 10,5 daN. Customization available.



MODEL	COVER DIMENSIONS	FRAME DIMENSIONS	FRAME HEIGHT	CLEAR OPENING	CERTIFICATE	UNITS PER PALLET
1175	Ø 645 mm	Ø 797 mm	50 mm	Ø 624 mm	AFNOR	10



TROTTOIR B125

HINGED ACCESS COVER



Hinge



Square Frame

Square frame with round hinged cover. Opening of up to 110°. The cover is supplied with a perimeter ridge that produces an hydraulic closing effect in the frame. Hydraulic frame prevents odour leakage. Anti-slip surface. Opened by standard tools (crowbar, pick). Opening force below 5 daN. Customization available.



MODEL	COVER DIMENSIONS	FRAME DIMENSIONS	FRAME HEIGHT	CLEAR OPENING	CERTIFICATE	UNITS PER PALLET
2132	Ø 176 mm	250 x 250 mm	20 mm	Ø 150 mm	AFNOR	48
2133	Ø 199 mm	317 x 317 mm	29 mm	Ø 173 mm	AFNOR	36
2135	Ø 274 mm	430 x 417 mm	29 mm	Ø 250 mm	AFNOR	36
2136	Ø 374 mm	530 x 530 mm	29 mm	Ø 350 mm	AFNOR	20
2137	Ø 444 mm	620 x 597 mm	34 mm	Ø 420 mm	AFNOR	12
2138	Ø 531 mm	694 x 694 mm	40 mm	Ø 500 mm	AFNOR	10
2139	Ø 624 mm	800 x 801 mm	40 mm	Ø 605 mm	AFNOR	8

***Options:** locking system by hexagonal bolt



LLUM B125

HALF-HINGED ACCESS COVER WITH HYDRAULIC FRAME



Hinge



Square Frame

Square manhole cover with hydraulic frame 45 mm high. Half-hinged cover with stable opening position of 105°, equipped with guiding system for closing manoeuvres that ensures perfect fitting of cover in frame.

The cover has a perimeter ridge that produces an hydraulic closing effect within the frame. Slot in the cover facilitates lifting. Normally used for installation in pedestrian areas, green areas, parks where vehicle access is only occasional. Anti-slip surface. Opened by standard tools (crowbar, pick). Opening force below 12 daN. Customization available.

MODEL	COVER DIMENSIONS	FRAME DIMENSIONS	FRAME HEIGHT	CLEAR OPENING	CERTIFICATE	UNITS PER PALLET
3140	239 x 239 mm	250 x 249 mm	37 mm	213 x 213 mm	AFNOR	36
3188	281 x 281 mm	292 x 292 mm	37 mm	205 x 255 mm	AFNOR	36
3145-10*	385 x 385 mm	397 x 397 mm	49 mm	305 x 353 mm	AFNOR/BVC	36
3145-10L	375 x 375 mm	400 x 400 mm	25 mm	320 x 320 mm	AFNOR**	36
3196-1*	481 x 461 mm	494 x 476 mm	48 mm	425 x 425 mm	AFNOR	20
3197-1*	581 x 563 mm	596 x 578 mm	48 mm	525 x 525 mm	AFNOR	20

*Options: locking system.

**In the process of certification



DRH B125

HYDRAULIC ACCESS COVER



Square Frame

Square manhole access with lifting mechanism for easier use. Hydraulic frame prevents odour leakage. Anti-slip surface. Opened by standard tools (crowbar, pick). Opening force below 12 daN. Customization available.

MODEL	COVER DIMENSIONS	FRAME DIMENSIONS	FRAME HEIGHT	CLEAR OPENING	CERTIFICATE	UNITS PER PALLET
3138	675 x 675 mm	692 x 692 mm	45 mm	618 x 603 mm	AFNOR	10
3139	780 x 780 mm	805 x 805 mm	45 mm	670 x 670 mm	AFNOR	5
3180	875 x 875 mm	900 x 900 mm	42 mm	805 x 805 mm	AFNOR	5

Options: locking system with hexagonal bolt.



TAR B125

RECESSED ACCESS COVER WITH HYDRAULIC FRAME



Square Frame

Square access cover refillable with bricks, concrete or stones. Hydraulic frame to prevent odour leakage. Interior infill depth of 50 mm.

MODEL	COVER DIMENSIONS	FRAME DIMENSIONS	FRAME HEIGHT	INFILL DEPTH	CERTIFICATE	UNITS PER PALLET
3406	490 x 490 mm	515 x 515 mm	77 mm	50 mm	BVC	20
3408	420 x 420 mm	443 x 443 mm	77 mm	50 mm	BVC	20

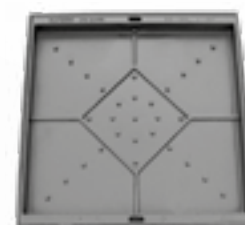

TELECOMMUNICATIONS

MATERIAL:

Casted device produced in micro alloy spheroidal graphite. Ductile cast iron according to EN -1563.

COATING:

EPOXY-POLYESTER BLACK ENAMEL, RAL-9004, thickness 100 microns, based on thermo stable plastic resins treated at high temperature. Compliant with Council Directive 1999/13/EC regarding exemption of solvents.



RETEL D400

TRIANGULAR ACCESS COVERS FOR TELECOMMUNICATIONS NORMAL TRAFFIC



Set formed by 2 or 4 triangular covers per frame. Hinged cover with maximum opening range of 110° and safety blocking at 90°. Hinges integrated into the frame. Anti-slip surface. Opened by standard tools (crowbar, pick). Customization available.

MODEL	COVER NR	FRAME DIMENSIONS	FRAME HEIGHT	CLEAR OPENING	CERTIFICATE	UNITS PER PALLET
10112	2 triangles	795 x 729 mm	100 mm	600 x 600 mm	BVC	16
10101	2 triangles	870 x 870 mm	100 mm	760 x 760 mm	AENOR	5
10101-S	2 triangles	925 x 925 mm	100 mm	760 x 760 mm	AENOR	5
10108	2 triangles	914 x 902 mm	100 mm	800 x 700 mm	AENOR	5
10103	4 triangles	1285 x 870 mm	100 mm	1180 x 760 mm	AENOR	8
10103-S	4 triangles	1340 x 925 mm	100 mm	1180 x 760 mm	AENOR	5
10113	4 triangles	1400 x 796 mm	120 mm	1200 x 600 mm	BVC	8
10102	4 triangles	1650 x 870 mm	100 mm	1545 x 760 mm	BVC	5
10102-S	4 triangles	1755 x 925 mm	100 mm	1545 x 760 mm	BVC	5



Options: locking system



RETEL DM B125

TELECOM ACCESS COVER

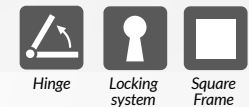

Set formed by 1 or 2 rectangular covers on galvanized steel frame. Hinged cover with opening up to 110°. Hinges integrated into the frame. Closing system protected by flange joined to elastic closing with automatic return. Anti-slip surface. Opened by standard tools (crowbar, pick). Opening force below 12 daN. Customization available.

MODEL	COVER DIMENSIONS	FRAME DIMENSIONS	FRAME HEIGHT	CLEAR OPENING	CERTIFICATE	UNITS PER PALLET
4124	896 x 580 mm	1020 x 595 mm	60 mm	900 x 475 mm	AENOR	10



Options: key with special head for opening the locking system



RETEL D OR H D400, B125



Tripod Fitting



Safety Blocking



Locking system



Hinge



Square Frame

Triangular access cover with maximum opening range of 110°, safety blocking at 90° angle and removable from the frame at 90°. Anti-slip surface. Special noise reduction design, optimising the fitting between the frame and the cover.

MODEL	COVER DIMENSIONS	FRAME DIMENSIONS	FRAME HEIGHT	CLEAR OPENING	CLASS	CERTIFICATE	UNITS PER PALLET
10107	4 triangles	1250x1060mm	80 mm	1090 x 900 mm	D400	AENOR	5
10107-S	4 triangles	1410x1220mm	80 mm	1090 x 900 mm	D400	AENOR	5
10108	2 triangles	914 x 902 mm	100 mm	800 x 700 mm	D400	AENOR	5
10109	2 triangles	945 x 845 mm	80 mm	800 x 700 mm	B125	-	5
10109-S	2 triangles	1060 x 960 mm	80 mm	800 x 700 mm	B125	-	5



Options: key with special head for opening the locking system

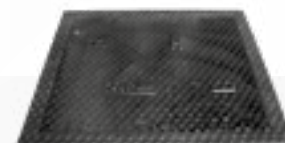
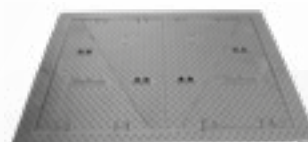

RETEL B125

RECTANGULAR ACCESS COVER FOR TELECOMMUNICATIONS



Square Frame

Rectangular access covers with cast-iron or angled steel frames. Cover equipped with lifting device for easy opening and closing. Anti-slip surface.

MODEL	COVER DIMENSIONS	FRAME DIMENSIONS	FRAME HEIGHT	CLEAR OPENING	CERTIFICATE	UNITS PER PALLET
4115	840 x 380 mm	930 x 852 mm	50 mm	800 x 720 mm	BVC	10

Options: locking system with pentagonal or hexagonal head bolt and key



RETEL VODAFONE B125

ACCESS COVER APPROVED BY VODAFONE



Safety Blocking



Locking system



Hinge



Square Frame

Set includes 1 or 2 rectangular covers on galvanized steel frame. Hinged cover with opening of up to 110°. Hinges integrated into the frame. Closing system protected by flange joined to elastic closing with automatic return. Anti-slip surface. Opened by standard tools (crowbar, pick). Opening force below 12 daN.

MODEL	COVER DIMENSIONS	FRAME DIMENSIONS	FRAME HEIGHT	CLEAR OPENING	CLASS	CERTIFICATE	UNITS PER PALLET
4118	700 x 595 mm	720 x 720 mm*	110 mm	600 x 600 mm	B125	BVC	10
4119	1196x700mm	1316x720mm*	110 mm	1200 x 600 mm	B125	-	5

Options: locking system





TELECOM / FIBRE / CABLE C250 B125

Rectangular access covers available in sets 1, 2, 3 covers with galvanized steel frame.

LT B125

TYPE	MODEL	DISTRIBUTION	CLEAR OPENING	FRAME HEIGHT	FRAME DIMENSIONS	CERTIFICATE
L0T	4120		428 x 248 mm	60 mm	508 x 328 mm	BVC
L1T	4121-1		527 x 389 mm	60 mm	647 x 509 mm	BVC
L2T	4121-1		1161 x 389 mm	60 mm	1281 x 509 mm	BVC
L3T	4121-1		1381 x 527 mm	60 mm	1501 x 647 mm	BVC
½ L4T	4121-1		884 x 527 mm	60 mm	1000 x 643 mm	BVC
	4120	Cover without frame			495 x 316 mm	BVC
	4121-1	Cover without frame			633 x 495 mm	BVC

Options: frames L0T, L1T, L2T, L3T

LT C250

TYPE	MODEL	DISTRIBUTION	CLEAR OPENING	FRAME HEIGHT	FRAME DIMENSIONS	CERTIFICATE
L1T	4122-1		527 x 389 mm	60 mm	647 x 509 mm	BVC
L2T	4122-1		1161 x 389 mm	60 mm	1281 x 509 mm	BVC
L3T	4122-1		1381 x 527 mm	60 mm	1501 x 647 mm	BVC
½ L4T	4122-1		884 x 527 mm	60 mm	1000 x 643 mm	BVC
L5T	4132		1787 x 880 mm	60 mm	1907 x 1000 mm	BVC
	4122-1	Cover without frame			633 x 495 mm	BVC
	4122-1	Cover without frame			632 x 493 mm	BVC

Options: frames L0T, L1T, L2T, L3T



MANHOLE COVERS TELECOM D400

L1C, L2C, L3C, L4C

Triangular access covers on galvanized steel frame. Product customization available.

MODEL	DISTRIBUTION	FRAME DIMENSIONS	FRAME HEIGHT	CLEAR OPENING	CERTIFICATE
10115 L1C		647 x 509 mm	120 mm	527 X 389 mm	BVC
10115 L2C		1281 x 509 mm	120 mm	1161 X 389 mm	BVC
10115 L3C		1501 x 647 mm	120 mm	1381 X 527 mm	BVC
10115 L4C		1890 x 647 mm	120 mm	1770 x 527 mm	BVC

Options: locking system with internal bolt, ductile iron frame



MANHOLE COVERS TELECOM D400

K1C, K2C, K3C, K4C

Triangular access covers on galvanized steel frame. Product customization available.

MODEL	DISTRIBUTION	FRAME DIMENSIONS	FRAME HEIGHT	CLEAR OPENING	CERTIFICATE
10116 K1C		913 x 910 mm	145 mm	752,5 x 750 mm	BVC
10116 K2C		1662 x 910 mm	145 mm	1502 x 750 mm	BVC
10116 K3C		2411 x 910 mm	145 mm	2251 x 750 mm	BVC
10116 K4C		3163,5 x 910 mm	145 mm	3004 x 750 mm	BVC

Options: locking system with internal bolt



ELECTRICAL ACCESS COVERS

MATERIALS:

Casted device produced in micro alloy spheroidal graphite. Ductile cast iron according to EN-1563

COATING:

EPOXY-POLYESTER BLACK ENAMEL, RAL-9004, thickness 100 microns, based on thermo stable plastic resins treated at high temperature. Compliant with the exemption of solvents Council Directive 1999/13/EC.



M2-T2 B125

REVERSIBLE COVER FOR PEDESTRIAN AREAS

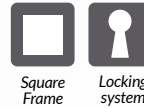

Access cover and frame. Opened with standard tools.

MODEL	COVER DIMENSIONS	FRAME DIMENSIONS	FRAME HEIGHT	CLEAR OPENING	CLASS	CERTIFICATE	UNITS PER PALLET
3121 - IBE - TM2	665 x 665 mm	684 x 684 mm	63,5 mm	632 x 632 mm	B125	AENOR	20
3121 - IBE - TM2 C/C	665 x 665 mm	684 x 684 mm	63,5 mm	632 x 632 mm	B125	AENOR	20



ENDESA A1 D400

ROADWAY ACCESS COVER APPROVED BY ENDESA MEDIUM TRAFFIC



Manhole cover designed and produced in accordance with technical specifications from ENDESA. Frame equipped with gasket to prevent noise and vibration. Opened with standard tools. Includes personalized ENDESA anagram.



MODEL	COVER DIMENSIONS	FRAME DIMENSIONS	FRAME HEIGHT	CLEAR OPENING	CLASS	CERTIFICATE	UNITS PER PALLET
3192-L	720 x 620 mm	816 x 716 mm	80 mm	680 x 574 mm	D400	AENOR	14



TRENCH 40 KN

MODULAR ACCESS SOLUTIONS

MODEL	COVER DIMENSIONS	FRAME DIMENSIONS	FRAME HEIGHT	CLEAR OPENING
4114	1005 x 387(x3) mm	1200 x 1200 mm	60 mm	1080 x 900 mm

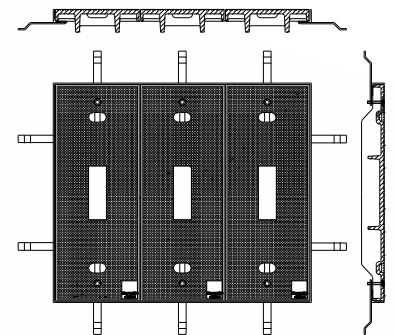

OTHER PRODUCTS

MATERIALS:

Casted device produced in micro alloy spheroidal graphite. Ductile cast iron according to EN-1563

COATING:

EPOXY-POLYESTER BLACK ENAMEL , RAL-9004, thickness 100 microns, based on thermo stable plastic resins treated at high temperature. Compliant with the exemption of solvents Council Directive 1999/13/EC.



SERVICE BOXES



MODEL	FRAME FORM	FRAME DIMENSIONS	BASE DIMENSIONS	FRAME HEIGHT	CLEAR OPENING
2162-150 E	HEXAGONAL	130 mm	Ø 150 mm	160 mm	Ø 80 mm
2162-150 R	ROUND	Ø130 mm	Ø 150 mm	160 mm	Ø 80 mm
2162-150 Q	SQUARE	130 x 130 mm	Ø 150 mm	160 mm	Ø 80 mm
2162-205 E	HEXAGONAL	130 mm	Ø 205 mm	160 mm	Ø 80 mm
2162-205 R	ROUND	Ø130 mm	Ø 205 mm	160 mm	Ø 80 mm
2162-205 Q	SQUARE	130 x 130 mm	Ø 205 mm	160 mm	Ø 80 mm

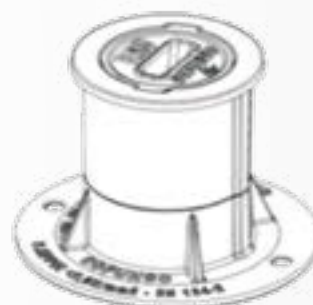
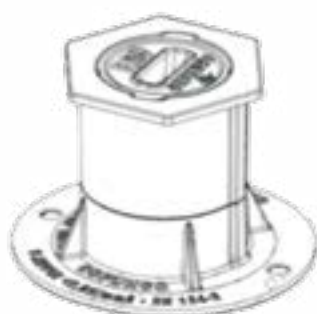



TABLE OF PRODUCTS BY TRAFFIC DENSITY

Actualización:
22-12-16

			PRODUCT NR		
	LIGHT VEHICLES	LIGHT GOODS VEHICLES	HEAVY VEHICLES		
MODERATE TRAFFIC /MD/lane: <2.600 Veh. (<110 Veh./h)				1178	
				1164 - 2164 1174 - 6174 1122 1168 1108-08 1173	
NORMAL TRAFFIC /MD/lane: 2.600 - 5.000 Veh. (110 - 210 Veh./h)					
INTENSE TRAFFIC /MD/lane 5.000 - 8.000 Veh. (210 - 330 Veh./h)					
VERY INTENSE TRAFFIC /MD/lane: >8.000 Veh. (>330 Veh./h)					
MODERATE TRAFFIC /MD/lane: <2.600 Veh. (<110 Veh./h)				1184 6184 1191 1193 1194	
NORMAL TRAFFIC /MD/lane: 2.600 - 5.000 Veh. (110 - 210 Veh./h)					
INTENSE TRAFFIC /MD/lane: 5.000 - 8.000 Veh. (210 - 330 Veh./h)				2130 1187 2184	
VERY INTENSE TRAFFIC /MD/lane: >8.000 Veh. (>330 Veh./h)					





Contact us

COFUNCO S.A.

Ctra. de la Pobla, 22.
08788 Vilanova del Camí
Barcelona (España)
Tel.: +34 938 03 46 97



www.cofunco.com
comercial@cofunco.com

May 2020